

GR-300XL - 1

30 Ton Capacity (27.2 Metric Tons)

HYDRAULIC ROUGH TERRAIN CRANE

DIMENSIONS

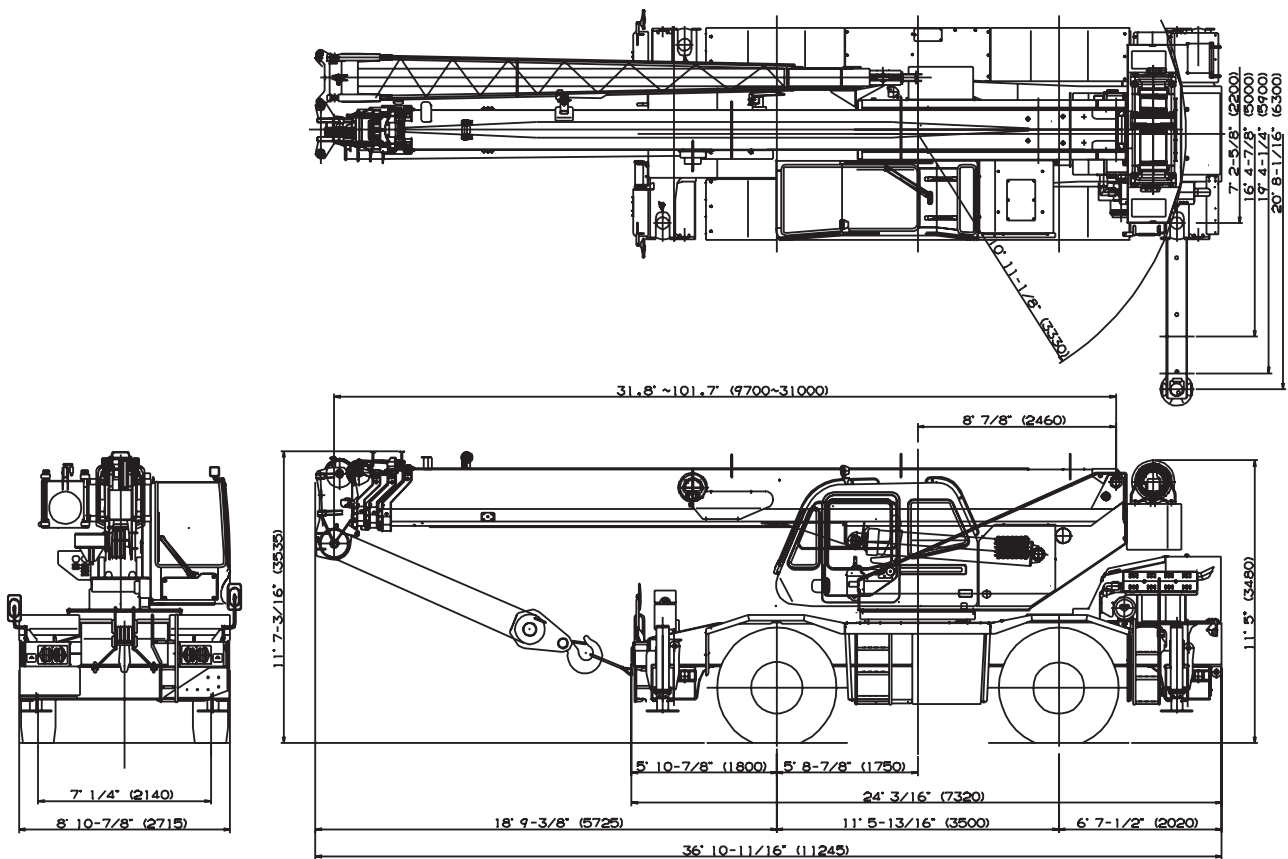

GENERAL DIMENSIONS (20.5 X 25 Tires)

	Feet	Meters
Turning radius		
4 wheel steer	20' 12"	6.4
2 wheel steer	36' 5"	11.1

CRANE SPECIFICATIONS

BOOM

Four section full power synchronized telescoping boom, 31.8'~101.7' (9.7m~31.0m), of round hexagonal box construction with three sheaves, 13-1/4" (0.336m) root diameter, at boom head. The synchronization system consists of two double acting telescope cylinders, an extension cable and retraction cable. Hydraulic cylinder fitted with holding valve. Two easily removable wire rope guards, rope dead end provided on both sides of boom head. Boom telescope sections are supported by wear pads both vertically and horizontally.
Extension speed: 31.8' to 101.7' in 91 seconds.

BOOM ELEVATION - By a double acting hydraulic cylinder with holding valve. Elevation 0°~81°, combination controls for hand or foot operation. Boom angle indicator. Automatic speed reduction and soft stop function. Elevating speed 0° to 81° in 44 seconds.

JIB - Two stage lattice type, 5°, 25° or 45° offset (tilt type). Single sheave, 13-7/8"(0.352m) root diameter, at jib head. Box type top section telescopes from lattice type base section which stores alongside base boom section. Jib length is 23.6' (7.2m) or 42' (12.8m).

AUXILIARY LIFTING SHEAVE (SINGLE TOP) - Single sheave, 13-1/4"(0.336m) root diameter. Mounted to main boom head for single line work (stowable).

ANTI-TWO BLOCK - Pendant type over-winding cut out device with audio-visual (FAILURE lamp/BUZZER) warning system.

SWING

Hydraulic axial piston motor driven through planetary swing speed reducer. Continuous 360° full circle swing on ball bearing turntable at 2.7rpm. Equipped with manually locked/released swing brake. A 360° positive swing lock for pick and carry and travel modes, manually engaged in cab. Twin swing system: Free swing or lock swing controlled by selector switch on front console. Automatic speed reduction and soft stop function.

HOIST

MAIN HOIST - Variable speed type with grooved drum driven by hydraulic axial piston motor through winch speed reducer. Power load lowering and raising. Equipped with automatic brake (neutral brake) and counterbalance valve. Controlled independently of auxiliary hoist. Equipped with cable follower and drum rotation indicator.

DRUM - Grooved 12-5/8"(0.32m) root diameter x 19-1/16" (0.485m) wide. Wire rope: 558' of 5/8"diameter rope (170m of 16mm). Drum capacity: 720' (219.5m) 6 layers. Maximum line pull (permissible): 12,600lbs. (5,710kg)*. Maximum line speed: 410FPM (125m/min).

AUXILIARY HOIST (OPTIONAL) - Variable speed type with grooved drum driven by hydraulic axial piston motor through winch speed reducer. Power load lowering and raising. Equipped with automatic brake (neutral brake) and counterbalance valve. Controlled independently of main hoist. Equipped with cable follower and drum rotation indicator.

DRUM - Grooved 12-5/8"(0.32m) root diameter x 10-3/8" (0.263m) wide. Wire rope: 322' of 5/8"diameter rope (98m of 16mm). Drum capacity: 392' (119.4m) 6 layers. Maximum line pull (permissible): 12,600lbs. (5,710kg)*. Maximum line speed: 410FPM (125m/min).

* Maximum permissible line pull may be affected by wire rope strength.

WIRE ROPE - Warrington seal wire, extra improved plow steel, preformed, independent wire rope core, right regular lay. 5/8"(16 mm) 6X37 class

HOOK BLOCKS

30 ton (27.2 metric ton) - 3 sheaves with swivel hook and safety latch, for 5/8"(16mm) wire rope.(OPTIONAL)
4.4 ton (4.0 metric ton) - Weighted hook with swivel and safety latch, for 5/8"(16mm) wire rope.

HYDRAULIC SYSTEM

PUMPS - Two variable piston pumps for crane functions. Tandem gear pump for steering, swing and optional equipment. Powered by carrier engine. Pump disconnect for crane is engaged/ disengaged by rotary switch from operator's cab.

CONTROL VALVES - Multiple valves actuated by pilot pressure with integral pressure relief valves.

RESERVOIR - 100 gallon (380 lit.) capacity. External sight level gauge.

FILTRATION - 26 micron return filter, full flow with bypass protection, located inside of hydraulic reservoir. Accessible for easy replacement.

OIL COOLER - Air cooled fan type.

CAB AND CONTROLS

Both crane and drive operations can be performed from one cab mounted on rotating superstructure.

Left side, 1 man type, steel construction with sliding door access and tinted safety glass windows opening at side. Door window is powered control. Windshield glass window and roof glass window are shatter-resistant. Tilt-telescoping steering wheel. Adjustable control lever stands for swing, boom hoist, boom telescoping, auxiliary hoist and main hoist. Control lever stands can change neutral positions and tilt for easy access to cab. Engine throttle knob. Foot operated controls: boom hoist, boom telescoping, service brake and engine throttle. Hot water cab heater and air conditioning (OPTIONAL).

Dash-mounted engine start/stop, monitor lamps, cigarette lighter, drive selector switch, parking brake switch, steering mode select switch, power window switch, pump engaged/ disengaged switch, swing brake switch, telescoping/auxiliary winch select switch, outrigger controls, free swing / lock swing selector switch.

Instruments - Torque converter oil temperature, engine water temperature, air pressure, fuel, speedometer, tachometer and hour meter. Hydraulic oil pressure is monitored and displayed on the AML-L display panel.

Tadano electronic LOAD MOMENT INDICATOR system (AML-L) including:

- Control lever lockout function with audible and visual pre-warning
- Lift status indicator
- Outrigger status indicator
- Load radius / boom angle / tip height / swing range preset function
- Warning buzzer
- Boom angle / boom length / jib offset angle / load radius / rated lifting capacities / actual loads read out
- Ratio of actual load moment to rated load moment indication
- Automatic Speed Reduction and Soft Stop function on boom elevation and/or swing
- Working condition register switch
- External warning lamp

TADANO AML-L monitors outrigger extended length and automatically programs the corresponding "RATED LIFTING CAPACITIES" table.

Both symmetrical and Non-symmetrical outrigger extension (deployment) is permitted.

Operator's right hand console includes transmission gear selector and sight level bubble. Upper console includes working light switch, roof washer and wiper switch, emergency outrigger set up key switch, jib equipped/removed select switch, boom emergency telescoping switch (2nd and 3rd-Top) and air conditioning control switch. Swing lock lever and 3 way adjustable seat with high back and seat belt.

NOTE: Each crane motion speed is based on unladen conditions.

CARRIER SPECIFICATIONS

TYPE - Rear engine, left hand steering, 4x2 front drive or 4x4 front and rear drive, selected by 2-way manual switch.

FRAME - High tensile steel, all welded mono-box construction.

TRANSMISSION - Electronically controlled full automatic transmission. Torque converter driving full powershift with driving axle selector. 8 forward and 2 reverse speeds, constant mesh.

- 4 speeds - high range - 2 wheel drive; 4 wheel drive
- 4 speeds - low range - 4 wheel drive

TRAVEL SPEED - 29 mph (47 km/h)

AXLE - Front: Full floating type, steering and driving axle with planetary reduction. Rear: Full floating type, steering and driving axle with planetary reduction and non-spin rear differential.

STEERING- Hydraulic power steering controlled by steering wheel. Three steering modes available: 2 wheel front, 4 wheel coordinated and 4 wheel crab.

SUSPENSION - Front: Semi-elliptic leaf springs with hydraulic lockout device. Rear: Semi-elliptic leaf springs with hydraulic lockout device.

BRAKE SYSTEMS - Service: Air over hydraulic disc brakes on all 4 wheels. Parking/Emergency: Spring applied-air released brake acting on input shaft of front axle. Auxiliary: Electro-pneumatic operated exhaust brake.

TIRES - 20.5-25 24PR(OR)

OUTRIGGERS - Four hydraulic beam and jack outriggers. Vertical jack cylinders equipped with integral holding valve. Each outrigger beam and jack is controlled independently from cab. Beams extend to 20'8-1/16" (6.3 m) center-line and retract to within 7'2-5/8" (2.2 m) overall width with floats. Outrigger jack floats are attached thus eliminating the need to manually attach and detach them. Controls and sight bubble located in superstructure cab. Four outrigger extension lengths are provided with corresponding "RATED LIFTING CAPACITIES" for crane duty in confined areas. Both symmetrical and Non-symmetrical outrigger extension (deployment) is permitted.

- Min. Extension 7' 2-5/8" center to center
- Mid. Extension 16' 4-7/8" center to center
- Mid. Extension 19' 4-1/4" center to center
- Max. Extension 20' 8-1/16" center to center

Float size (Diameter) 1'3-3/4"(0.4m)

ENGINE

Model	Cummins QSB6.7
Type	Direct injection diesel
No. of cylinders	6
Combustion	4 cycle, turbo charged and after cooled
BoreXStroke, in.(mm)	4.212 X 4.882 (107X124)
Displacement, cu. in (liters)	409 (6.700)
Air inlet heater	24 volt preheat
Air cleaner	Dry type, replaceable element
Oil filter	Full flow with replaceable element
Fuel filter	Full flow with replaceable element
Fuel tank, gal.(liters)	79.2 (300), right side of carrier
Cooling	Liquid pressurized, recirculating by-pass

Radiator	Fin and tube core, thermostat controlled
Fan, in.(mm)	Suction type, 6-blade, 28 (711) dia.
Starting	24 volt
Charging	24 volt system, negative ground
Battery	2-120 amp. Hour
Compressor, air, CFM(l /min)	15.2 CFM (430) at 2,500rpm
Horsepower (kW)	Gross 215 (129) at 2,500rpm
Torque, Max. ft-lb (kgm)	620 (86) at 1,600rpm
Capacity, gal.(liters)	
Cooling water	2.7 (10)
Lubrication	4.0 (15)
Fuel	79.2 (300)

STANDARD EQUIPMENT

- Four section full power partially synchronized boom 31.8'~101.7' (9.7 m~31.0 m)
- Auxiliary lifting sheave (single top) stowable
- 23.6'~42' (7.2 m~12.8 m) lattice jib (tilt type) with 5°, 25° or 45° pinned offsets and self storing pins.
- Variable speed main hoist with grooved drum, cable follower and 558' of 5/8" cable.
- Variable speed auxiliary hoist with grooved drum, cable follower, drum rotation indicator (thumper type) and 322' of 5/8" cable.
- Drum rotation indicator (thumper type) main hoist
- Anti-Two block device (overwind cutout)
- Tadano electronic load moment indicator system (AML-L)
- Outrigger extension length detector
- Electronic crane monitoring system
- Tadano twin swing system and 360° positive swing lock
- Self centering finger control levers with pilot control
- Control pedals for boom hoist and boom telescoping
- 3 way adjustable cloth seat with armrests, high back and seat belt
- Tilt-telescoping steering wheel
- Tinted safety glass and sun visor
- Front windshield wiper and washer
- Roof window wiper and washer
- Power window (cab door)
- Rear view mirrors (right and left side)
- Cigarette lighter
- Hot water cab heater and air conditioner
- Electric fan in cab
- Cab floor mat
- Pump disconnect in operator's cab
- Hydraulic oil cooler
- Independently controlled outriggers
- Four outrigger extension positions
- Self-storing outrigger pads
- Cummins QSB5.9-30TAA turbo charged after cooled engine(173HP) with exhaust brake
- Electronic controlled automatic transmission drive by torque converter
- 4 X 4 X 4 drive/steer
- Non-spin rear differential
- Hydraulic lockout suspension system
- 20.5-25 24PR (OR) tires
- Disc brakes
- Fenders
- Air dryer
- Water separator with filter
- Engine over-run alarm
- Back-up alarm
- Low oil pressure/high water temp. warning device(visual)
- Rear steer centering light
- Air cleaner dust indicator
- Full instrumentation package
- Complete highway light package
- Work lights
- Tool storage compartment
- Tire inflation kit
- 24 volt electric system
- 4.4 ton (4.0 metric ton) hook with swivel
- 30 ton (27.2 metric ton) 3 sheave hook block
- Towing hooks-Front and rear
- Lifting eyes
- Hook block tie down (front bumper)
- Weighted hook storage compartment

HOISTING PERFORMANCE

Layer	Main or auxiliary hoist - 12-5/8" (0.32m) drum, 5/8" (16mm) wire rope									
	Line speeds ²		Line pulls				Drum grooved lagging			
			Available ¹		Permissible ⁴		Total wire rope			
	F.P.M	m/min	Lbs.	kgf	Lbs.	kgf	main winch		auxiliary winch	
						Feet	Meters	Feet	Meters	
1st	305	93	14,900	6,750	12,600	5,710	98.8	30.1	53.8	16.4
2nd	331	101	13,500	6,120	11,500	5,210	206.4	62.9	112.2	34.2
3rd	357	109	12,400	5,620	10,500	4,760	322.2	98.2	175.2	53.4
4th	387	118	11,400	5,170	9,700	4,400	446.2	136.0	242.8	74.0
5th	410	125	10,600	4,800	9,000	4,080	579.1	176.5	315.0	96.0
6th ³	436	133	9,900	4,490	8,400	3,800	720.1	219.5	391.7	119.4

¹ Developed by machinery with each layer of wire rope, but not based on rope strength or other limitation in machinery or equipment.

² Line speeds based only on hook block, not loaded.

³ Sixth layer of wire rope is not recommended for hoisting operations.

⁴ Permissible line pull may be affected by wire rope strength.

DRUM DIMENSIONS

		Inch	mm
Root diameter		12-5/8"	320
Length	Main	19-1/16"	484
	Auxiliary	10-3/8"	263
Flange diameter		20-7/8"	530

GR-300XL-1 WORKING RANGE CHART

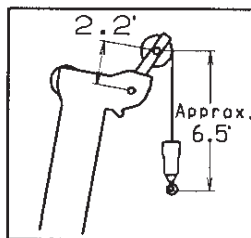
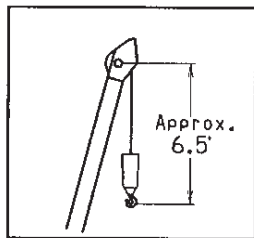
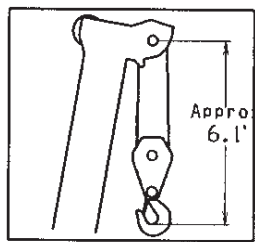
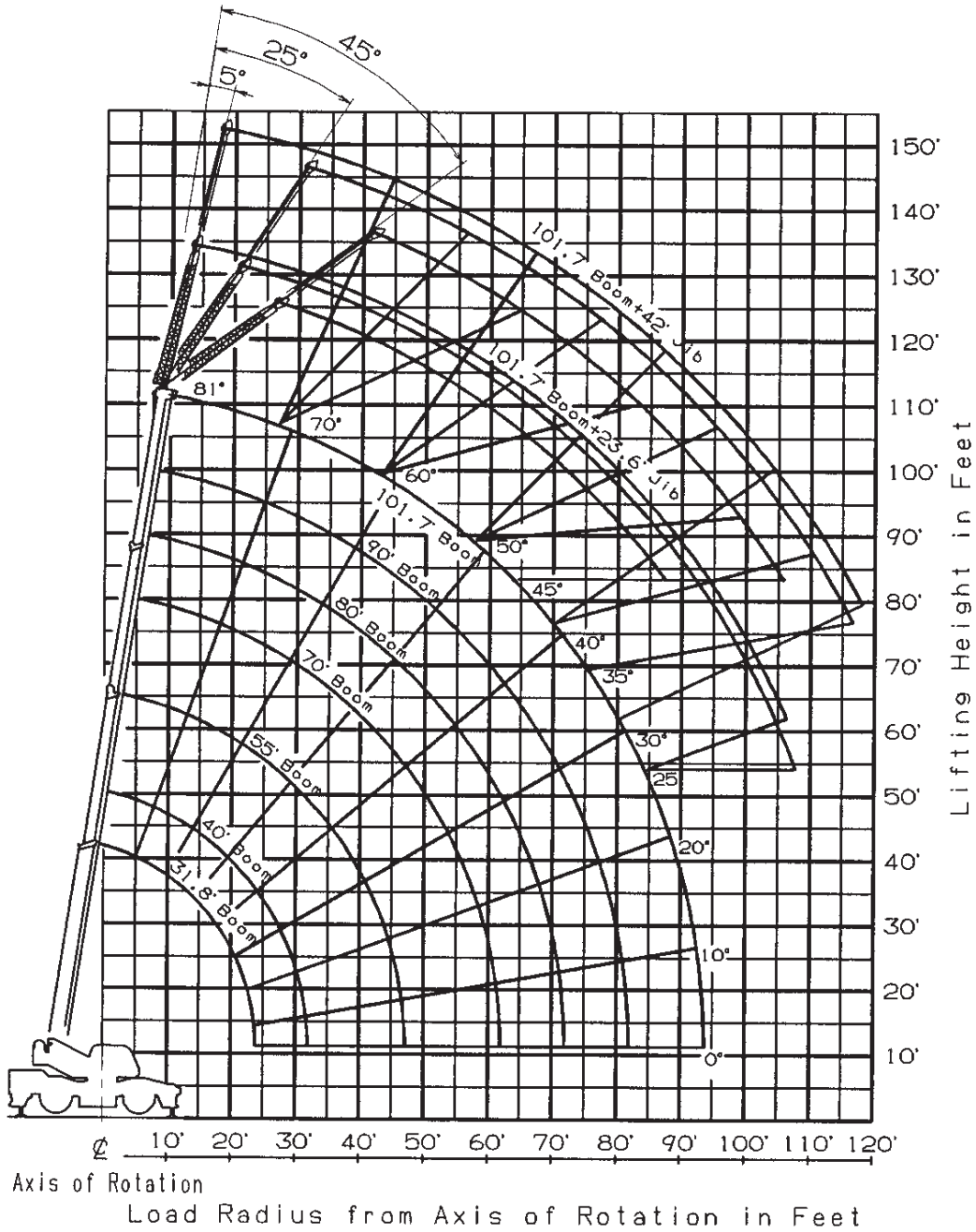

Boom Length in Feet

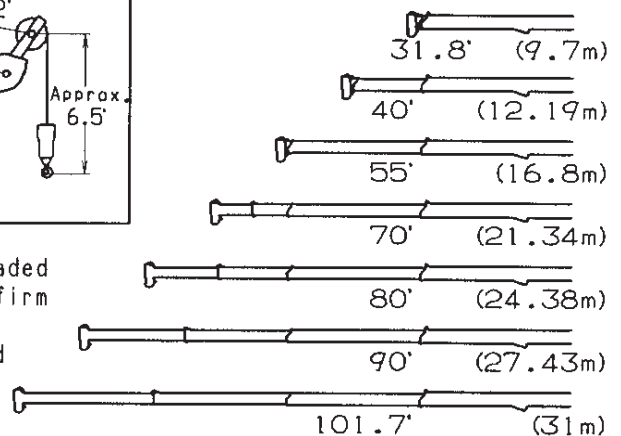

NOTE: Boom and jib geometry shown are for unloaded condition and machine standing level on firm supporting surface. Boom deflection and subsequent radius and boom angle change must be accounted for when applying load to hook.

GR-300XL-1 RATED LIFTING CAPACITIES (IN POUNDS)

ON OUTRIGGERS FULLY EXTENDED 20' 8-1/16" (6.3m) SPREAD														
360° ROTATION														
A	31.8'		40'		55'		70'		80'		90'		101.7'	
	C	(9.7m)	C	(12.19m)	C	(16.8m)	C	(21.34m)	C	(24.38m)	C	(27.43m)	C	(31.0m)
10	60.2	60,000	67.1	49,600	74.1	42,300	77.8	27,500						
12	55.6	56,500	63.8	49,600	71.9	42,300	76.1	27,500	78.2	27,500				
15	48.7	46,500	58.8	46,000	68.7	40,000	73.6	27,500	76.0	27,500	78.3	25,300		
20	33.8	36,000	49.6	35,500	62.8	32,000	69.4	27,500	72.4	27,200	75.2	23,500	77.3	18,500
25			38.4	28,500	56.5	25,900	64.8	24,200	68.7	22,700	71.8	20,400	74.5	18,100
30			22.4	20,500	49.7	20,100	60.1	20,100	64.7	19,400	68.4	17,800	71.6	16,300
35					42.0	15,800	55.0	16,700	60.4	16,000	64.9	15,300	68.4	14,400
40					32.7	12,200	49.7	13,100	56.0	13,250	61.1	13,050	65.2	12,600
45					19.2	9,250	43.6	10,300	51.2	10,600	57.2	11,000	62.1	11,000
50							36.8	8,400	46.1	8,700	53.0	8,900	58.6	9,300
55							28.6	6,650	40.7	7,100	48.6	7,300	55.0	7,800
60							16.3	5,400	34.3	5,900	43.8	6,200	51.1	6,450
65									26.6	4,800	38.6	5,100	47.3	5,300
70									14.9	3,700	32.7	4,300	42.8	4,400
75											25.4	3,650	38.1	3,800
80											14.9	3,000	32.9	3,200
85													26.5	2,600
90													18.3	2,200
D														0°

LIFTING CAPACITIES AT ZERO DEGREE BOOM ANGLE ON OUTRIGGERS FULLY EXTENDED														
20' 8-1/16" (6.3m) SPREAD 360° ROTATION														
A	31.8'		40'		55'		70'		80'		90'		101.7'	
	B	(9.7m)	B	(12.19m)	B	(16.8m)	B	(21.34m)	B	(24.38m)	B	(27.43m)	B	(31.0m)
0°	23.7	30,400	31.9	18,700	46.9	8,600	61.9	5,000	71.9	3,400	81.9	2,800	93.6	1,900

ON OUTRIGGERS MID EXTENDED 19' 4-1/4" (5.9m) SPREAD														
360° ROTATION														
A	31.8'		40'		55'		70'		80'		90'		101.7'	
	C	(9.7m)	C	(12.19m)	C	(16.8m)	C	(21.34m)	C	(24.38m)	C	(27.43m)	C	(31m)
10	60.2	60,000	67.1	49,600	74.1	42,300	77.8	27,500						
12	55.6	56,500	63.8	49,600	71.9	42,300	76.1	27,500	78.2	27,500				
15	48.7	46,500	58.8	46,000	68.7	40,000	73.6	27,500	76.0	27,500	78.3	25,300		
20	33.8	34,700	49.6	35,500	62.8	32,000	69.4	27,500	72.4	27,200	75.2	23,500	77.3	18,500
25			38.4	24,000	56.5	23,700	64.8	24,200	68.7	22,700	71.8	20,400	74.5	18,100
30			22.4	16,700	49.6	16,500	60.1	17,900	64.7	18,300	68.4	17,300	71.6	16,300
35					41.9	12,250	55.0	13,400	60.3	13,850	64.7	14,150	68.4	13,250
40					32.7	9,050	49.4	10,300	55.9	10,700	60.9	11,200	65.2	11,200
45					19.2	6,750	43.4	8,000	51.2	8,350	57.0	8,800	61.8	9,100
50							36.7	6,300	46.1	6,700	52.7	7,050	58.3	7,300
55							28.5	4,850	40.5	5,300	48.3	5,700	54.7	6,000
60							16.2	3,800	34.2	4,200	43.5	4,600	50.9	4,800
65									26.6	3,300	38.3	3,700	46.9	4,000
70									15.0	2,600	32.5	2,900	42.6	3,200
75											25.2	2,300	37.8	2,600
80											14.6	1,700	32.5	2,000
85													26.3	1,400
90													17.9	800
D														0°

LIFTING CAPACITIES AT ZERO DEGREE BOOM ANGLE ON OUTRIGGERS MID EXTENDED														
19' 4-1/4" (5.9m) SPREAD 360° ROTATION														
A	31.8'		40'		55'		70'		80'		90'		101.7'	
	B	(9.7m)	B	(12.19m)	B	(16.8m)	B	(21.34m)	B	(24.38m)	B	(27.43m)	B	(31m)
0°	23.7	26,500	31.9	15,000	46.9	6,000	61.9	3,400	71.9	2,300	81.9	1,450	93.6	500

- A** :Boom length in feet
- B** :Load radius in feet
- C** :Loaded boom angle (deg.)
- D** :Minimum boom angle (deg.) for indicated length (no load)

GR-300XL-1 RATED LIFTING CAPACITIES (IN POUNDS)

ON OUTRIGGERS MID EXTENDED 16' 4-7/8" (5.0m) SPREAD														
360° ROTATION														
A \ B	31.8'		40'		55'		70'		80'		90'		101.7'	
	C	(9.7m)	C	(12.19m)	C	(16.8m)	C	(21.34m)	C	(24.38m)	C	(27.43m)	C	(31m)
10	60.2	60,000	67.1	49,600	74.1	42,300	77.8	27,500						
12	55.6	56,500	63.8	49,600	71.9	42,300	76.1	27,500	78.2	27,500				
15	48.7	46,500	58.8	46,000	68.7	40,000	73.6	27,500	76.0	27,500	78.3	25,300		
20	33.8	28,300	49.6	27,600	62.7	27,000	69.4	27,500	72.6	27,200	75.2	23,500	77.3	18,500
25			38.4	18,300	56.3	17,800	64.7	19,200	68.5	19,600	71.9	19,900	74.5	18,100
30			22.2	12,700	49.5	12,700	59.9	13,800	64.4	14,200	68.2	14,750	71.5	15,000
35					41.8	9,000	54.8	10,000	60.1	10,500	64.4	11,000	68.1	11,300
40					32.4	6,500	49.3	7,500	55.7	8,000	60.6	8,400	64.9	8,700
45					18.7	4,700	43.4	5,700	51.0	6,200	56.7	6,500	61.5	6,800
50							36.5	4,300	45.9	4,700	52.5	5,100	58.0	5,400
55							28.3	3,200	40.3	3,600	48.1	4,000	54.5	4,300
60							16.4	2,300	33.9	2,700	43.4	3,100	50.7	3,400
65									26.2	2,000	38.2	2,400	46.7	2,600
70									15.0	1,300	32.2	1,700	42.4	2,000
75											25.0	1,200	37.6	1,400
80											14.4	700	32.2	1,000
D	0°												20°	

LIFTING CAPACITIES AT ZERO DEGREE BOOM ANGLE ON OUTRIGGERS														
MID EXTENDED 16' 4-7/8" (5.0m) SPREAD 360° ROTATION														
A \ C	31.8'		40'		55'		70'		80'		90'			
	B	(9.7m)	B	(12.19m)	B	(16.8m)	B	(21.34m)	B	(24.38m)	B	(27.43m)		
0°	23.7	20,700	31.9	11,300	46.9	4,100	61.9	2,100	71.9	1,100	81.9	500		

ON OUTRIGGERS MIN EXTENDED 7' 2-5/8" (2.2m) SPREAD														
360° ROTATION														
A \ B	31.8'		40'		55'		70'		80'		90'		101.7'	
	C	(9.7m)	C	(12.19m)	C	(16.8m)	C	(21.34m)	C	(24.38m)	C	(27.43m)	C	(31m)
10	60.2	28,600	67.0	27,500	73.8	27,900	77.8	27,500						
12	55.9	20,900	63.6	20,800	71.6	20,300	76.0	21,600	78.2	22,700				
15	48.6	14,600	58.7	14,100	68.3	13,800	73.4	15,000	75.7	15,600	77.8	16,500		
20	33.2	7,900	49.4	8,200	62.2	7,700	68.9	8,900	71.8	9,400	74.4	10,000	76.6	10,300
25			38.3	4,900	56.0	4,500	64.2	5,600	67.9	6,000	70.9	6,500	73.5	6,700
30			22.2	2,600	49.1	2,300	59.4	3,400	63.8	3,800	67.4	4,200	70.4	4,400
35					41.5	1,000	54.4	1,900	59.6	2,300	63.7	2,600	67.2	2,900
40									55.2	1,200	59.9	1,500	64.1	1,800
D	0°			36°			45°		51°		54°		58°	

LIFTING CAPACITIES AT ZERO DEGREE BOOM ANGLE ON OUTRIGGERS														
MIN EXTENDED 7' 2-5/8" (2.2m) SPREAD 360° ROTATION														
A \ C	31.8'		40'											
	B	(9.7m)	B	(12.19m)										
0°	23.7	5,600	31.9	2,000										

- A** :Boom length in feet
- B** :Load radius in feet
- C** :Loaded boom angle (deg.)
- D** :Minimum boom angle (deg.) for indicated length (no load)

Boom Length in Feet (meters)	31.8' (9.7m)	31.8' to 55' (9.7m to 16.8m)	55' to 101.7' (16.8m to 31.0m)	Single top Jib
Number of parts of line	8	6	4	1

GR-300XL-1 RATED LIFTING CAPACITIES (IN POUNDS)

ON OUTRIGGERS FULLY EXTENDED 20' 8-1/16" (6.3m) SPREAD 360° ROTATION													
C	101.7' (31m) Boom + 23.6' (7.2m) Jib						C	101.7' (31m) Boom + 42' (12.8m) Jib					
	5° Tilt		25° Tilt		45° Tilt			5° Tilt		25° Tilt		45° Tilt	
	R	W	R	W	R	W		R	W	R	W	R	W
80°	19.3	7,700	26.7	5,200	32.1	3,700	80°	25.6	4,800	38.0	2,600	47.8	1,700
77.5°	25.2	7,700	32.0	5,000	37.2	3,600	77.5°	32.2	4,800	44.3	2,600	53.4	1,700
75°	30.8	7,700	37.5	4,800	42.4	3,500	75°	38.8	4,800	50.4	2,600	58.6	1,700
72.5°	36.4	7,350	42.7	4,600	47.1	3,400	72.5°	44.9	4,400	56.1	2,450	63.9	1,700
70°	41.8	7,000	47.7	4,400	52.1	3,300	70°	50.9	4,000	61.6	2,300	68.9	1,650
67.5°	47.0	6,600	52.9	4,250	56.6	3,200	67.5°	56.8	3,700	67.1	2,200	73.9	1,600
65°	52.0	6,200	57.5	4,100	61.0	3,150	65°	62.3	3,400	72.2	2,050	78.5	1,600
62.5°	56.8	5,700	62.4	3,950	65.2	3,100	62.5°	67.9	3,150	77.4	1,950	83.0	1,550
60°	61.4	5,200	66.8	3,800	69.5	3,050	60°	73.1	2,900	82.1	1,850	87.3	1,500
57.5°	65.8	4,700	71.2	3,650	73.4	3,000	57.5°	78.6	2,750	86.7	1,800	91.4	1,450
55°	70.3	4,200	75.3	3,500	77.4	2,900	55°	83.5	2,600	91.4	1,750	95.4	1,400
52.5°	74.3	3,700	79.2	3,300	81.0	2,800	52.5°	88.3	2,450	95.9	1,700	99.0	1,400
50°	78.4	3,200	82.9	3,100	84.5	2,650	50°	93.0	2,300	99.8	1,600	102.0	1,350
47.5°	82.2	2,900	86.2	2,750	87.9	2,500	47.5°	97.4	2,100	104.0	1,550	106.0	1,350
45°	85.8	2,600	89.6	2,400	90.9	2,400	45°	102.0	1,900	107.0	1,500	110.0	1,350
42.5°	89.3	2,300	92.8	2,150			42.5°	105.0	1,700	111.0	1,400		
40°	92.6	2,000	95.7	1,900			40°	109.0	1,500	114.0	1,300		
37.5°	95.7	1,750	98.6	1,650			37.5°	113.0	1,350	117.0	1,150		
35°	98.6	1,500	101.0	1,400			35°	116.0	1,200	120.0	1,000		
32.5°	101.0	1,350	104.0	1,250			32.5°	119.0	1,050				
30°	104.0	1,200	106.0	1,100			30°	122.0	900				
27.5°	106.0	1,050	108.0	1,000									
25°	108.0	900	110.0	900									

- C** :Loaded boom angle (deg.)
- R** :Load radius in feet
- W** :Rated lifting capacity in pounds

GR-300XL-1 RATED LIFTING CAPACITIES (IN POUNDS)

ON OUTRIGGERS MID EXTENDED 19' 4-1/4" (5.9m) SPREAD 360° ROTATION													
C	101.7' (31m) Boom + 23.6' (7.2m) Jib						C	101.7' (31m) Boom + 42' (12.8m) Jib					
	5° Tilt		25° Tilt		45° Tilt			5° Tilt		25° Tilt		45° Tilt	
	R	W	R	W	R	W		R	W	R	W	R	W
80°	19.3	7,700	26.7	5,200	32.1	3,700	80°	25.6	4,800	38.0	2,600	47.8	1,700
77.5°	25.2	7,700	32.0	5,000	37.2	3,600	77.5°	32.2	4,800	44.3	2,600	53.4	1,700
75°	30.8	7,700	37.5	4,800	42.4	3,500	75°	38.8	4,800	50.4	2,600	58.6	1,700
72.5°	36.4	7,350	42.7	4,600	47.1	3,400	72.5°	44.9	4,400	56.1	2,450	63.9	1,700
70°	41.8	7,000	47.7	4,400	52.1	3,300	70°	50.9	4,000	61.6	2,300	68.9	1,650
67.5°	47.1	6,600	52.9	4,250	56.6	3,200	67.5°	56.8	3,700	67.1	2,200	73.9	1,600
65°	52.1	6,200	57.5	4,100	61.0	3,150	65°	62.3	3,400	72.2	2,050	78.5	1,600
62.5°	56.7	5,700	62.3	3,950	65.4	3,100	62.5°	67.9	3,150	77.4	1,950	83.0	1,550
60°	61.1	5,200	66.6	3,800	69.5	3,050	60°	73.1	2,900	82.1	1,850	87.3	1,500
57.5°	65.6	4,350	70.7	3,500	73.5	2,950	57.5°	78.2	2,700	86.9	1,800	91.4	1,450
55°	69.9	3,500	74.8	3,200	77.2	2,850	55°	82.9	2,500	91.2	1,750	95.4	1,400
52.5°	74.0	2,950	78.6	2,750	80.9	2,550	52.5°	87.7	2,150	95.7	1,650	99.0	1,350
50°	78.0	2,400	82.4	2,300	84.2	2,200	50°	92.1	1,850	99.8	1,500	103.0	1,300
47.5°	81.8	2,050	86.0	1,950	87.6	1,900	47.5°	96.5	1,550	104.0	1,350	106.0	1,200
45°	85.3	1,750	89.5	1,650	90.7	1,650	45°	101.0	1,300	107.0	1,200	109.0	1,100
42.5°	88.9	1,500	92.6	1,350									
40°	92.2	1,200	95.6	1,100									

ON OUTRIGGERS MID EXTENDED 16' 4-7/8" (5.0m) SPREAD 360° ROTATION													
C	101.7' (31m) Boom + 23.6' (7.2m) Jib						C	101.7' (31m) Boom + 42' (12.8m) Jib					
	5° Tilt		25° Tilt		45° Tilt			5° Tilt		25° Tilt		45° Tilt	
	R	W	R	W	R	W		R	W	R	W	R	W
80°	19.3	7,700	26.7	5,200	32.1	3,700	80°	25.6	4,800	38.0	2,600	47.8	1,700
77.5°	25.2	7,700	32.0	5,000	37.2	3,600	77.5°	32.2	4,800	44.3	2,600	53.4	1,700
75°	30.8	7,700	37.5	4,800	42.4	3,500	75°	38.8	4,800	50.4	2,600	58.6	1,700
72.5°	36.4	7,100	42.7	4,600	47.1	3,400	72.5°	44.9	4,400	56.1	2,450	63.9	1,700
70°	41.5	6,500	47.7	4,400	52.1	3,300	70°	50.9	4,000	61.6	2,300	68.9	1,650
67.5°	46.7	5,950	52.7	4,350	56.6	3,200	67.5°	56.8	3,700	67.1	2,200	73.9	1,600
65°	51.5	5,400	57.5	4,100	61.0	3,100	65°	62.3	3,400	72.2	2,050	78.5	1,600
62.5°	56.1	4,500	61.8	3,650	65.2	3,000	62.5°	67.5	3,050	77.4	1,950	83.0	1,500
60°	60.5	3,600	66.2	3,200	69.3	2,950	60°	72.7	2,750	82.1	1,850	87.1	1,400
57.5°	64.8	3,000	70.5	2,700	73.1	2,500	57.5°	77.6	2,250	86.6	1,600	91.3	1,400
55°	69.2	2,400	74.4	2,200	76.9	2,100	55°	82.4	1,750	90.9	1,400	95.0	1,400
52.5°	73.4	2,050	78.3	1,750	80.3	1,750	52.5°	86.8	1,400	95.1	1,200	99.1	1,200
50°	77.2	1,650	81.9	1,400	83.8	1,400	50°	91.2	1,100	99.4	1,000	102.4	1,000
47.5°	81.4	1,350											
45°	85.0	1,000											

- C** :Loaded boom angle (deg.)
- R** :Load radius in feet
- W** :Rated lifting capacity in pounds

WARNING AND OPERATING INSTRUCTIONS FOR LIFTING CAPACITIES

GENERAL

1. RATED LIFTING CAPACITIES apply only to the machine as originally manufactured and normally equipped by TADANO LTD. Modifications to the machine or use of optional equipment other than that specified can result in a reduction of capacity.
2. Hydraulic cranes can be hazardous if improperly operated or maintained. Operation and maintenance of this machine must be in compliance with information in the **Operation and Maintenance Manual** supplied with the crane. If this manual is missing, order a replacement through the distributor.
3. The operator and other personnel associated with this machine shall fully acquaint themselves with the latest American National Standards Institute (ANSI) safety standards for cranes.

SET UP

1. Rated lifting capacities on the load chart are the maximum allowable crane capacities. They are based on the machine standing level on firm supporting surface under ideal job conditions. Depending on the nature of the supporting surface, it may be necessary to have structural supports under the outrigger floats or tires to spread the loads to a larger surface.
2. For outrigger operation, outriggers shall be properly extended with tires free of supporting surface before operating crane.

OPERATION

1. Rated lifting capacities have been tested to and meet minimum requirements of SAE J1063-Cantilevered Boom Crane Structures Method of Test.
2. Rated lifting capacities do not exceed 85 % of the tipping load on outriggers fully extended as determined by SAE J765-Crane Stability Test Code. Rated lifting capacities for partially extended outriggers are determined by this formula, Rated Lifting Capacities = (Tipping Load - 0.1 x Tip Reaction) / 1.25.
3. Rated lifting capacities above bold lines in the chart are based on crane strength and those below, on its stability. They are based on actual load radius increased by boom deflection.
4. The weight of handling device such as hook blocks, slings, etc., must be considered as part of the load and must be deducted from the lifting capacities.
5. Rated lifting capacities are based on freely suspended loads and make no allowance for such factors as the effect of wind, sudden stopping of loads, supporting surface conditions, inflation of tires, operating speeds, side loads, etc. Side pull on the boom or jib is extremely dangerous.
6. Rated lifting capacities do not account for the effects of wind on a lifted load or boom. Rated lifting capacities and boom length shall be appropriately reduced, when wind velocity exceeds 20 mph (9 m/sec.).
7. Rated lifting capacities at load radius shall not be exceeded. Do not tip the crane to determine allowable loads.
8. Do not operate at boom lengths, radii, or boom angle, where no capacities are shown. Crane may overturn without any load on the hook.
9. When boom length is between values listed, refer to the rated lifting capacities of the next longer and next shorter booms for the same radius. The lesser of the two rated lifting capacities shall be used.

10. When making lifts at a load radius not shown, use the next longer radius to determine allowable capacity.
11. Load per line should not exceed 8,820 lbs. (4,000kg) for main winch and auxiliary winch.
12. Check the actual number of parts of line with LOAD MOMENT INDICATOR (AML-L) before operation. Maximum lifting capacity is restricted by the number of parts of line of LOAD MOMENT INDICATOR (AML-L). Limited capacity is as determined from the formula, Single line pull for main winch (8,820 lbs.) x number of parts of line.
13. The boom angle before loading should be greater to account for deflection. For rated lifting capacities, the loaded boom angle and the load radius is for reference only.
14. The 31.8' (9.7m) boom length capacities are based on boom fully retracted. If not fully retracted [less than 40' (12.19m) boom length], use the rated lifting capacities for the 40' (12.19m) boom length.
15. Extension or retraction of the boom with loads may be attempted within the limits of the RATED LIFTING CAPACITIES. The ability to telescope loads is limited by hydraulic pressure, boom angle, boom length, crane maintenance, etc.
16. For lifting capacity of single top, reduce the rated lifting capacities of relevant boom according to a weight reductions for auxiliary load handling equipment. Capacities of single top shall not exceed 8,820 lbs. (4,000kg) including main hook.
17. When base jib or top jib or both jib removing, jib state switch select removed.
18. When erecting and stowing jib, be sure to retain it by hand or by other means to prevent its free movement.
19. Use "ANTI-TWO BLOCK" disable switch when erecting and stowing jib and when stowing hook block. While the switch is pushed, the hoist does not stop, even when overwind condition occurs.
20. For boom length with 23.6' (7.2m) jib, rated lifting capacities are determined by loaded boom angle only in the column headed "101.7' (31.0m) boom + 23.6' (7.2m) jib".
For boom length with 42' (12.8 m) jib, rated lifting capacities are determined by loaded boom angle only in the column headed "101.7' (31.0m) boom + 42' (12.8m) jib".
For angles not shown, use the next lower loaded boom angle to determine allowable capacity.
21. When lifting a load by using jib (aux. winch) and boom (main winch) simultaneously, do the following:
 - Enter the operation status as jib operation, not as boom operation.
 - Before starting operation, make sure that mass of load is within rated lifting capacity for jib.

DEFINITIONS

1. Load Radius: Horizontal distance from a projection of the axis of rotation to supporting surface before loading to the center of the vertical hoist line or tackle with load applied.
2. Loaded Boom Angle: The angle between the boom base section and the horizontal, after lifting the rated lifting capacity at the load radius.
3. Working Area: Area measured in a circular arc about the centerline of rotation.
4. Freely Suspended Load: Load hanging free with no direct external force applied except by the hoist line.
5. Side Load: Horizontal side force applied to the lifted load either on the ground or in the air.

GR-300XL-1 RATED LIFTING CAPACITIES (IN POUNDS)

ON RUBBER																TIRE : 20.5-25 24PR								
A	Stationary												Creep											
	OVER FRONT						360° ROTATION						OVER FRONT											
	31.8'		40'		55'		70'		31.8'		40'		55'		70'		31.8'		40'		55'		70'	
B	C	(9.7m)	C	(12.19m)	C	(16.8m)	C	(21.34m)	C	(9.7m)	C	(12.19m)	C	(16.8m)	C	(21.34m)	C	(9.7m)	C	(12.19m)	C	(16.8m)	C	(21.34m)
10	60.3	41,400	67.0	32,700					60.2	24,400	66.9	22,700					60.3	32,000	66.9	29,200				
12	55.7	37,900	63.8	32,700					55.9	18,200	63.6	17,400					55.7	27,800	63.6	27,500				
15	48.5	27,000	58.8	26,200	68.4	24,500			48.5	12,400	58.6	12,000	68.1	13,200			48.5	22,800	58.7	22,600	68.2	21,900		
20	33.5	16,800	49.5	16,500	62.4	15,700	69.1	16,450	33.2	7,200	49.4	6,900	62.3	7,850	68.8	7,900	33.6	16,800	49.5	16,500	62.5	15,700	69.1	16,450
25			38.4	11,200	56.1	10,700	64.4	11,700			38.1	4,200	56.0	4,700	64.1	4,750			38.2	11,200	56.1	10,700	64.4	11,700
30			22.1	7,950	49.3	7,500	59.6	8,450			22.2	2,200	49.1	2,900	59.4	2,900			22.2	7,950	49.3	7,500	59.6	8,450
35					41.6	5,100	54.5	6,200							54.3	1,700					41.6	5,100	54.5	6,200
40					32.3	3,650	49.2	4,500													32.3	3,650	49.2	4,500
45					18.7	2,400	43.1	3,300													18.7	2,400	43.1	3,300
50							36.4	2,400															36.4	2,400
55							28.1	1,600															28.1	1,600
60							16.0	1,200															16.0	1,200
D	0°						0°						38°		49°		0°							

LIFTING CAPACITIES AT ZERO DEGREE BOOM ANGLE ON RUBBER OPERATION																							
A	Stationary												Creep										
	OVER FRONT						360° ROTATION						OVER FRONT										
	31.8'		40'		55'		70'		31.8'		40'		55'		70'		31.8'		40'		55'		70'
C	B	(9.7m)	B	(12.19m)	B	(16.8m)	B	(21.34m)	B	(9.7m)	B	(11.0m)	B	(9.7m)	B	(12.19m)	B	(16.8m)	B	(16.8m)	B	(21.34m)	
0°	23.7	11,900	31.9	6,800	46.9	2,300	61.9	1,000	23.7	4,800	31.9	1,600		23.7	12,100	31.9	6,800	46.9	2,300	61.9	1,000		

A : Boom length in feet
 B : Load radius in feet
 C : Loaded boom angle (deg.)
 D : Minimum boom angle (deg.) for indicated length (no load)

NOTE: Standard number of parts of line for on rubber operation should be according to the following table.

Boom length in feet (meters)	31.8' (9.7)	31.8' to 70' (9.7 to 21.34)	Single top
Number of parts of line	6	4	1

The lifting capacity data stored in the LOAD MOMENT INDICATOR (AML-L) is based on the standard number of parts of line listed in the chart.

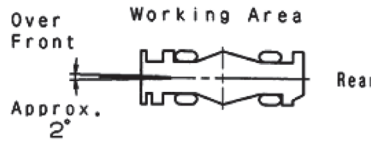

WARNING AND OPERATING INSTRUCTIONS FOR ON RUBBER LIFTING CAPACITIES

- Rated lifting capacities on rubber are in pounds and do not exceed 75 % of tipping loads as determined by SAE J765-Crane Stability Test Code.
- Rated lifting capacities shown in the chart are based on condition that crane is set on firm level surfaces with axle oscillation lockout applied. Those above bold lines are based on tire capacity and those below, on crane stability. They are based on actual load radius increased by tire deformation and boom deflection.
- If the axle oscillation lockout cylinders contain air, the axle will not be locked completely and rated lifting capacities may not be obtainable. Bleed the cylinders according to the operation safety and maintenance manual.
- Rated lifting capacities are based on proper tire inflation, capacity and condition. Damaged tires are hazardous to safe operation of crane.
- Tires shall be inflated to correct air pressure.
- Over front operation shall be performed within two degrees in front of chassis.
- On rubber lifting with "jib" is not permitted. Maximum permissible boom length is 70 ft. (21.34m).
- When making lift on rubber stationary, set parking brake.
- For creep operation, boom must be centered over front of machine, swing lock engaged, and load restrained from swinging. Travel slowly and keep the lifted load as close to the ground as possible, and especially avoid any abrupt steering, accelerating or braking.
- Do not operate the crane while carrying the load.
- Creep is motion for crane not to travel more than 200 ft. (60 m) in any 30 minute period and to travel at the speed of less than 1mph (1.6km/h).
- For creep operation, set Drive select switch to "4-WHEEL (Lo)" and set gear shift lever to "1".

Tires	Air Pressure
20.5-25 24PR	93 psi (6.5 kgf/cm ²)

WARNING AND OPERATING INSTRUCTIONS FOR USING THE LOAD MOMENT INDICATOR (AML-L)

1. When operating crane on outriggers:
 - Set P.T.O. switch to "ON".
 - Press the outrigger mode select key to register for the outrigger operation. Press the register key, then the outrigger mode indicative symbol changes from flashing to a solid light.
 - Press the lift mode select key to select the lift status that corresponds to the actual boom configuration. Each time the lift mode select key is pressed, the status changes. Press the register key to register the lift status, then the lift indicative symbol changes from flashing to a solid light.
 - When mounting and stowing jib, select the jib set status. (jib state indicative symbol flicker).
2. When operating crane on rubber:
 - Set P.T.O. switch to "ON".
 - Press the outrigger mode select key. The on-tire mode indicative symbol comes on. Each time the outrigger mode select key is pressed the mode changes. Select the creep operation, the on-tire mode indicative symbol flicker.
 - Press the lift mode select key to register the boom or single top lift. However, pay attention to the following.
 - (1) For stationary operation.
 - The front capacities are attainable only when the over front position symbol comes on. When the boom is more than 2 degrees from centered over front of chassis, 360° capacities are in effect.
 - When a load is lifted in the front position and then swung to the side area, make sure the value of the LOAD MOMENT INDICATOR(AML-L) is below the 360° lifting capacity.
 - (2) For creep operation.
 - The creep capacities are attainable only when boom is in the straight forward position of chassis and the over front position symbol is on. If boom is not in the straight forward position of chassis, never lift load.
3. This crane is equipped with an automatic swing sensor/stopping device.(For the details,see Operation & Maintenance Manual.) However, the automatic swing stop does not activate in the following cases.
 - When the "SWING STOP OVERRIDE" switch is turned ON.
 - During ON-RUBBER operation.
 - When the "P.T.O." switch is set to "OVERRIDE" and the "AML OVERRIDE" key switch outside the cab is ON.
4. During crane operation, make sure that the displays on front panel are in accordance with actual operating conditions.
5. The displayed values of LOAD MOMENT INDICATOR (AML-L) are based on freely suspended loads and make no allowance for such factors as the effect of wind, sudden stopping of loads, supporting surface conditions, inflation of tire, operating speed, side loads, etc. For safe operation, it is recommended when extending and lowering boom or swinging, lifting loads shall be appropriately reduced.
6. LOAD MOMENT INDICATOR (AML-L) is intended as an aid to the operator. Under no condition should it be relied upon to replace use of capacity charts and operating instruction. Sole reliance upon LOAD MOMENT INDICATOR (AML-L) aids in place of good operating practice can cause an accident. The operator must exercise caution to assure safety.

GR-300XL-1 Axle weight distribution chart

	Pounds			Kilograms		
	GVW	Front	Rear	GVW	Front	Rear
Base machine	59,183	28,986	30,197	26,845	13,148	13,697
Remove: 1. 30 ton (27.2 metric ton) hook block	-555	-1,111	556	-252	-504	252
2. 4.4 ton (4.0 metric ton) hook ball	-221	-309	88	-100	-140	40
3. Hot water cab heater and air conditioner	-209	-57	-152	-95	-26	-69
4. Auxiliary lifting sheave	-110	-269	159	-50	-122	72
5. 2-stage jib(7.2m, 12.8m)	-1,389	-2,392	1,003	-630	-1,085	455

MEMO

TADANO AMERICA CORPORATION

4242 WEST GREENS ROAD

HOUSTON, TEXAS 77066 U.S.A.

PHONE: (281) 869-0030 EXT. 315

FAX: (281) 869-0040

Parts Hotline: (281) 869-0033

Service Hotline: (281) 869-5925

Web site: www.tadanoamerica.com

E-mail: sales@tadano-cranes.com

Form No. TAC-GR-300XL-01-080125